

BVL SERRULAC

la technique a toujours raison dans le temps

VICTORIA

© modèle déposé



Déclinée en trois dimensions, elle s'intègre très facilement par sa forme simple à de nombreux types de constructions anciennes, ou modernes.



Les possibilités de coloris en **standard** :

RAL 9005 satiné

RAL 7016 satiné

RAL 9010 brillant

RAL 8019 satiné

en **option** :
- nuancier RAL
- d'autres finitions : fine texture, sablée, métallisée, ...

Les possibilités de remplissages en **standard** :



polycarbonate plein 4 mm INCOLORE



polycarbonate plein 4 mm BRONZE

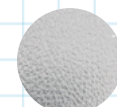

polycarbonate plein 4 mm GRANITÉ

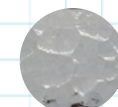

verre trempé sécurit 4 mm MONUMENTAL INCOLORE



verre trempé sécurit 4 mm INCOLORE

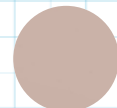

verre trempé sécurit 4 mm BRONZE

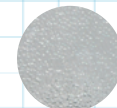

verre trempé sécurit 4 mm GRANITÉ

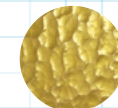

verre trempé sécurit 4 mm MONUMENTAL JAUNE

autres matériaux en **option** :
tôle aluminium thermolaquée pleine, autres verres trempés, ...

Les possibilités d'adaptation en **option** :



Victoria 1400

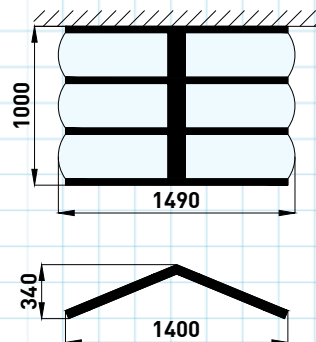

Victoria 1800

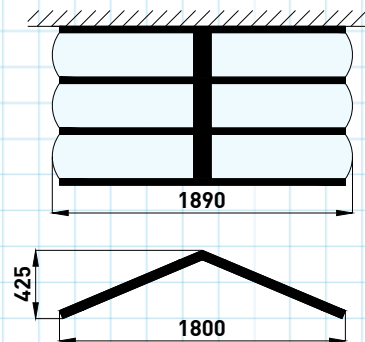

Victoria 2200

