

entreprise lyonnaise
spécialiste de l'aluminium cintré soudé
depuis + de 70 ans !

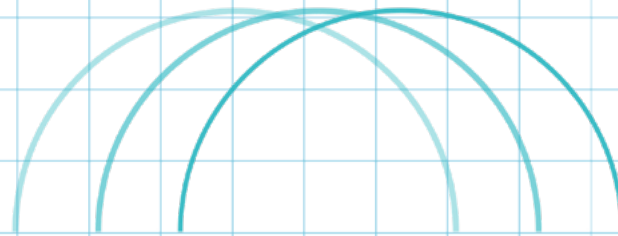

BVL SERRULAC

la technique a toujours raison dans le temps



LA COLLECTION MARQUISES

- EN ALUMINIUM SOUDÉ -
- PRÊTES À VITRER -

© *modèles déposés*

www.bvl-serrulac.com

MARQUISES | MENUISERIES CINTRÉES | CINTRAGE | ABRIS INDUSTRIELS

L'ACTU DES MARQUISES ...

L'ÉVOLUTION DES GARNITURES TRANSPARENTES (OU PAS !) DES MARQUISES

AU FIL DES ANNÉES, PLUSIEURS MATÉRIAUX SONT AJOUTÉS À LA GAMME

> en **polycarbonate plein**, disponible dans trois versions : incolore / teinté bronze / ou granité (en 3, ou 4 mm d'épaisseur, selon le modèle),

> en **verre trempé Sécurité*** de 4 mm disponible dans trois versions : incolore / teinté bronze / ou granité

> en **verre trempé dit « monumental »*** : c'est une surface irrégulière, disponible en deux versions : incolore / jaune

ET EN OPTIONS :

> en **verre trempé armé*** de 6 mm : petites mailles ou grandes mailles, les deux confèrent un charme rétro d'atelier, et brisent la vision, sans ôter la luminosité,
> ou avec des matériaux comme la tôle d'aluminium thermolaquée, du verre bleu, vert, sérigraphié, dépoli, etc. ... à étudier avec notre bureau d'études.

* à l'exception des modèles de forme bombée

QUELLE EST LA DIFFÉRENCE ENTRE UNE MARQUISE ET UN AUVENT ?



ET UN TUNNEL ?
ET UN PASSAGE COUVERT ?
ET UNE BANDE FILANTE ?

Juste la taille !

Outre les dimensions standard que nous présentons ici sur nos plans, nous pouvons adapter certains de nos modèles à vos mesures spéciales.

Notre bureau d'études peut même concevoir un produit unique pour vous.

LE SAVIEZ-VOUS ? ISOLATION THERMIQUE

Une marquise permet d'améliorer le coefficient thermique de votre porte d'entrée ...

ADAPTABILITÉ

SI, C'EST POSSIBLE !

d'adapter certains de nos modèles :

> à vos mesures spéciales,

> de leur ajouter des protections latérales,

> d'installer des LED,

> ou encore de concevoir un produit complètement unique pour vous ...



POLYCARBONATE PLEIN DÉFINITION

Le *Polycarbonate* est un verre synthétique qui présente exactement la même transparence que le verre, et qui a une très grande résistance aux chocs.



AJOUTONS DES JOUES LATÉRALES CONTRE LES INTEMPÉRIES !

Une seule, voire deux, peuvent être nécessaires de chaque côté ... C'est possible sur six modèles de marquises !

JOUES

IDÉE LUMINEUSE

2 en 1

- Eclairer sa porte d'entrée pour
- créer une ambiance douce et
- chaleureuse, pratique pour
- rechercher & insérer ses clefs dans la serrure, et visionner à
- travers le judas ?
- Oui c'est possible sur quatre
- modèles de marquise, équipée de
- LED en option !

LED

TOUS LES MODÈLES DE MARQUISES



la technique a toujours raison dans le temps

	BOREAL					page 04
	CLASSIC					page 05
	COROLLE					page 06
	ECLIPSE					page 07
	ELYSA					page 08
	EMPIRE					page 09
	LAURA					page 10
	MARGUERITE					page 11
	PALACE					page 12
	ROMANE					page 13
	TRIANON					page 14
	TRIANON RETRO					page 15
	VICTORIA					page 16
	VICTORIA BANDEAU					page 17
	STELLA					page 18
	VILA					page 19

LEGENDE des pictogrammes :

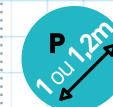

ajout de joue(s) sur le(s) côté(s)

largeur au choix : sans limite

profondeur au choix : jusqu'à 2 mètres (2000 mm) maxi

2 profondeurs au choix : 1 mètre (1000 mm) ou 1,2 mètres (1200 mm)

plusieurs profondeurs spécifiques à consulter auprès du bureau d'études

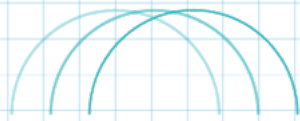

BVL SERRULAC

la technique a toujours raison dans le temps

BORÉAL

© modèle déposé



Marquise aluminium avec chéneaux latéraux, déjà vitrée & prête à poser.

Les possibilités de coloris en **standard** :

RAL 9005 satiné

RAL 7016 satiné

RAL 9010 brillant

RAL 8019 satiné

en **option** :

- nuancier RAL
- d'autres finitions : fine texture, sablée, métallisée, ...



Les possibilités de remplissages en **standard** :



polycarbonate plein 3 mm INCOLORE

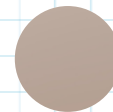

polycarbonate plein 3 mm BRONZE

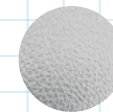

polycarbonate plein 4 mm GRANITÉ

autres matériaux en **option** :

tôle aluminium thermolaquée pleine, ...



Boréal 1600

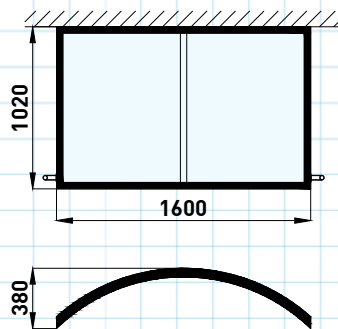

Boréal 2000

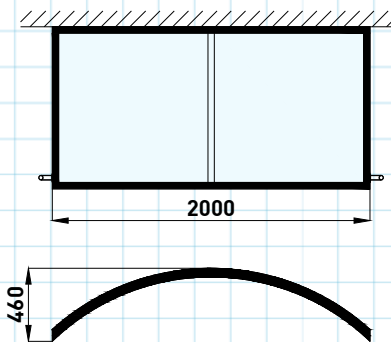

Boréal 2400

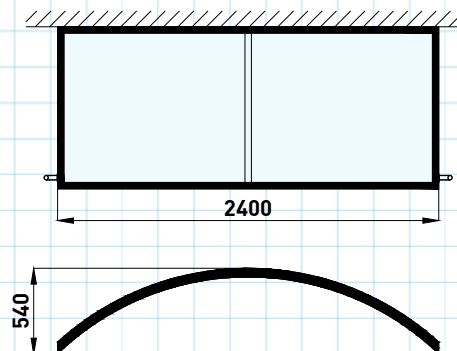

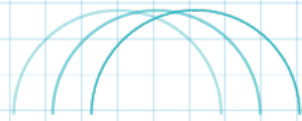

BVL SERRULAC
la technique a toujours raison dans le temps

CLASSIC

© modèle déposé

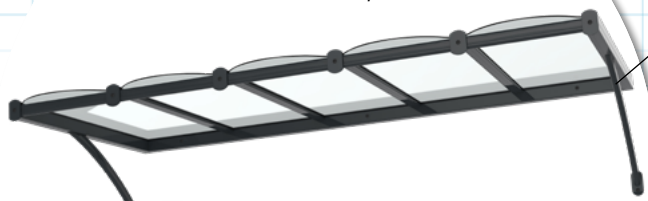

Simple et élégante avec ses jambes de force cintrées, ce modèle réalisé en aluminium soudé, assure avec discrétion une excellente protection de votre porte d'entrée.



Les possibilités de coloris en **standard** :

RAL 9005 satiné

RAL 7016 satiné

RAL 9010 brillant

RAL 8019 satiné

en **option** :
- nuancier RAL
- d'autres finitions : fine texture, sablée, métallisée, ...

Les possibilités de remplissages en **standard** :



polycarbonate plein 4 mm INCOLORE



polycarbonate plein 4 mm BRONZE

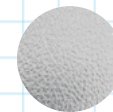

polycarbonate plein 4 mm GRANITÉ

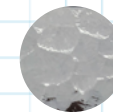

verre trempé sécurit 4 mm MONUMENTAL INCOLORE



verre trempé sécurit 4 mm INCOLORE

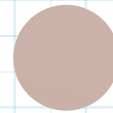

verre trempé sécurit 4 mm BRONZE

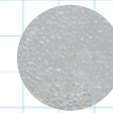

verre trempé sécurit 4 mm GRANITÉ

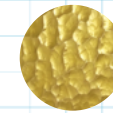

verre trempé sécurit 4 mm MONUMENTAL JAUNE

autres matériaux en **option** :
tôle aluminium thermolaquée pleine, autres verres trempés, ...

Les possibilités d'adaptation en **option** :



Classic 1200

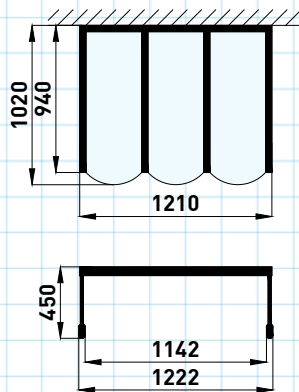

Classic 1600

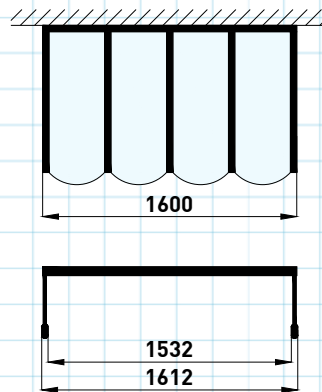

Classic 2000

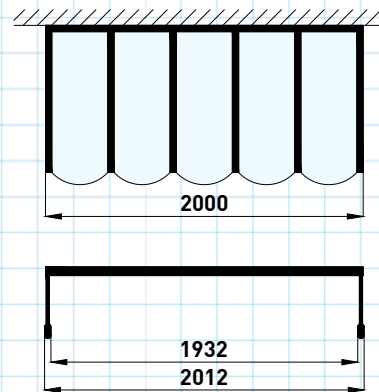

Classic 2400

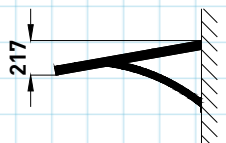
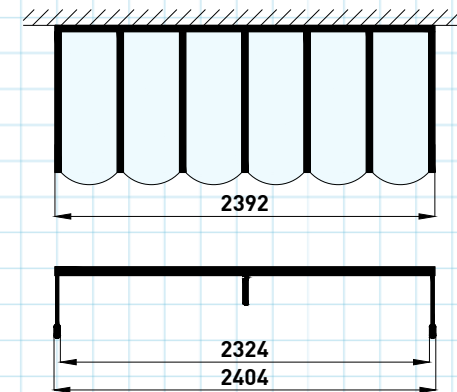

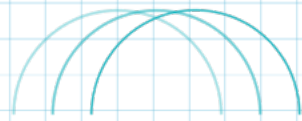

BVL SERRULAC

la technique a toujours raison dans le temps

COROLLE

© modèle déposé



Corolle est un produit contemporain et technique, dans la tradition des marquises d'antan.



Les possibilités de coloris en **standard** :

RAL 9005 satiné

RAL 7016 satiné

RAL 9010 brillant

RAL 8019 satiné

en **option** :

- nuancier RAL
- d'autres finitions : fine texture, sablée, métallisée, ...

Les possibilités de remplissages en **standard** :



polycarbonate plein 4 mm INCOLORE



polycarbonate plein 4 mm BRONZE

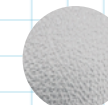

polycarbonate plein 4 mm GRANITÉ

SIMULATEUR
des couleurs alu & de tous les remplissages
vision à 360°



Corolle 1600

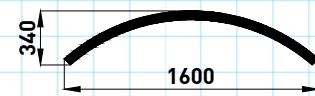
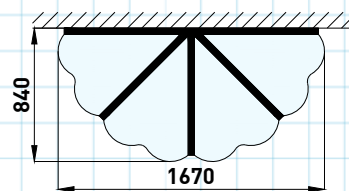

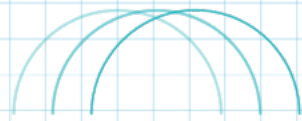

BVL SERRULAC

la technique a toujours raison dans le temps

ÉCLIPSE

© modèle déposé



A la fois original et fonctionnel, ce modèle habille aussi bien les constructions anciennes que modernes. Son chéneau cintré protège des gouttes de ruissellement.

Les possibilités de coloris en **standard** :

RAL 9005 satiné

RAL 7016 satiné

RAL 9010 brillant

RAL 8019 satiné

en **option** :

- nuancier RAL
- d'autres finitions : fine texture, sablée, métallisée, ...



Les possibilités de remplissages en **standard** :



polycarbonate plein 3 mm INCOLORE

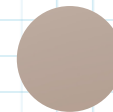

polycarbonate plein 3 mm BRONZE

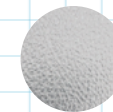

polycarbonate plein 3 mm GRANITÉ

SIMULATEUR
des couleurs alu & de tous les remplissages

vision à **360°**



Eclipse 2000

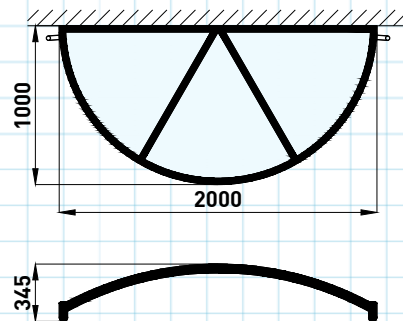

Eclipse 2400

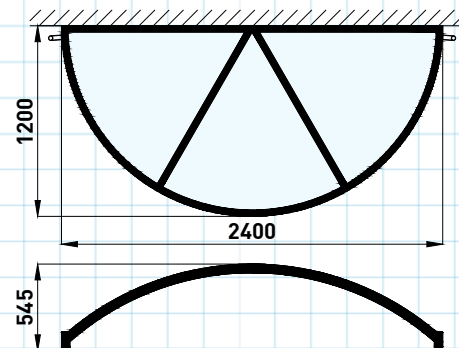

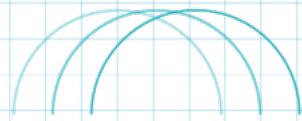

BVL SERRULAC

la technique a toujours raison dans le temps

ÉLYSA

© modèle déposé



La conception à facettes de ce modèle très demandé, apporte à la fois une touche rétro et contemporaine.



Les possibilités de coloris en **standard** :

RAL 9005 satiné

RAL 7016 satiné

RAL 9010 brillant

RAL 8019 satiné

en **option** :
- nuancier RAL
- d'autres finitions :
fine texture, sablée, métallisée, ...

Les possibilités de remplissages en **standard** :



polycarbonate plein 4 mm INCOLORE



polycarbonate plein 4 mm BRONZE

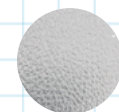

polycarbonate plein 4 mm GRANITÉ

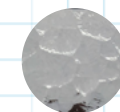

verre trempé sécurit 4 mm MONUMENTAL INCOLORE



verre trempé sécurit 4 mm INCOLORE

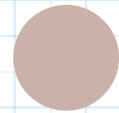

verre trempé sécurit 4 mm BRONZE

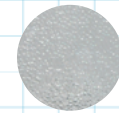

verre trempé sécurit 4 mm GRANITÉ

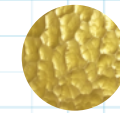

verre trempé sécurit 4 mm MONUMENTAL JAUNE

autres matériaux en **option** :
tôle aluminium thermolaquée pleine, autres verres trempés, ...

Les possibilités d'adaptation en **option** :



Elysa 1600

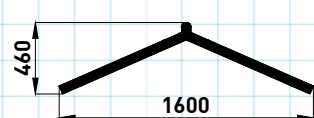
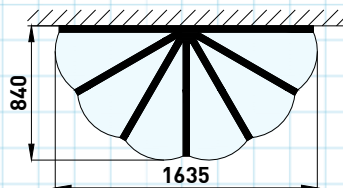

Elysa 2000

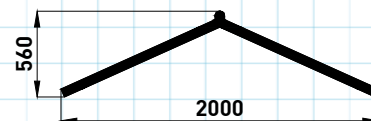
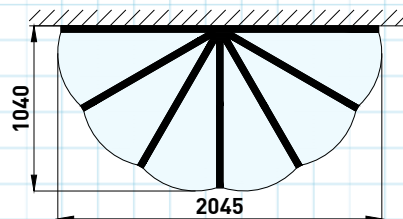

Elysa HORS STANDARD

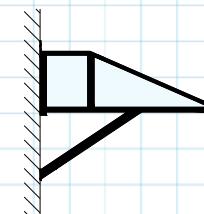
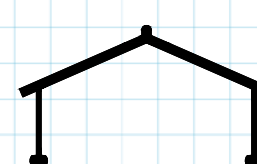
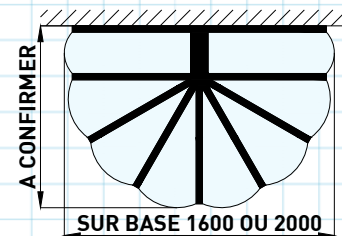

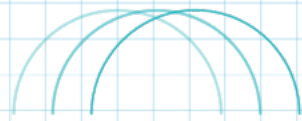

BVL SERRULAC

la technique a toujours raison dans le temps

EMPIRE

© modèle déposé



Simple par sa forme, et équipée d'un chéneau à l'avant pour protéger des gouttes de ruissellement.



Les possibilités de coloris en **standard** :

RAL 9005 satiné

RAL 7016 satiné

RAL 9010 brillant

RAL 8019 satiné

en **option** :
- nuancier RAL
- d'autres finitions : fine texture, sablée, métallisée, ...

Les possibilités de remplissages en **standard** :



polycarbonate plein 3 mm INCOLORE



polycarbonate plein 3 mm BRONZE

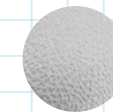

polycarbonate plein 3 mm GRANITÉ

autres matériaux en **option** :
tôle aluminium thermolaquée pleine, ...

Les possibilités d'adaptation en **option** :

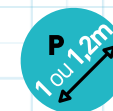

SIMULATEUR
des couleurs alu & de tous les remplissages

vision à 360°

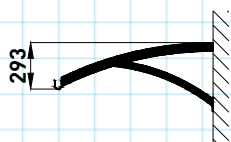

Empire 1400

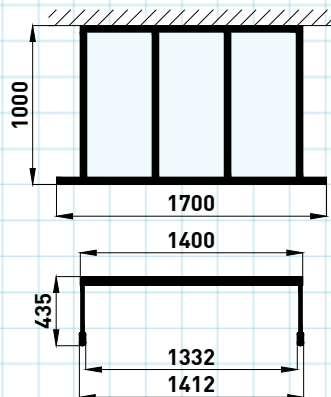

Empire 1600

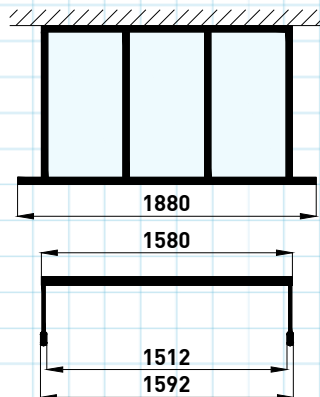

Empire 2000

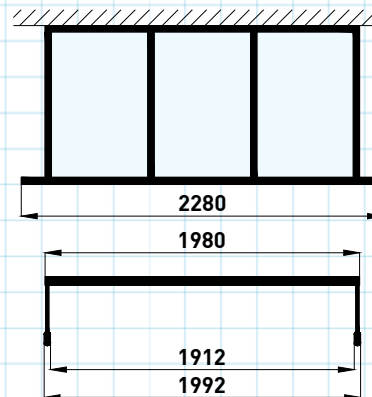

Empire 2300

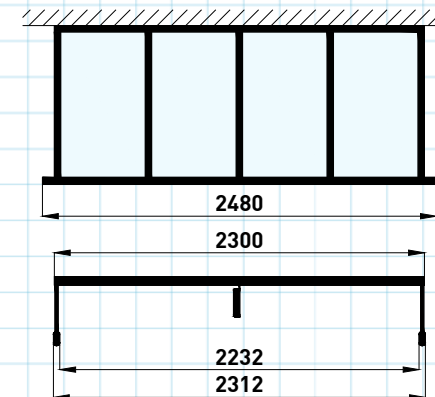

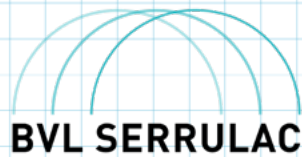

la technique a toujours raison dans le temps

LAURA

© modèle déposé



Laura est conçue pour s'adapter uniquement aux angles de murs à 90°.



Les possibilités de coloris en **standard** :

RAL 9005 satiné

RAL 7016 satiné

RAL 9010 brillant

RAL 8019 satiné

en **option** :
- nuancier RAL
- d'autres finitions : fine texture, sablée, métallisée, ...

Les possibilités de remplissages en **standard** :



polycarbonate plein 4 mm INCOLORE



polycarbonate plein 4 mm BRONZE

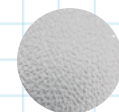

polycarbonate plein 4 mm GRANITÉ

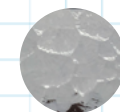

verre trempé sécurit 4 mm MONUMENTAL INCOLORE



verre trempé sécurit 4 mm INCOLORE

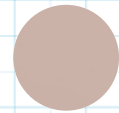

verre trempé sécurit 4 mm BRONZE

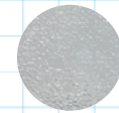

verre trempé sécurit 4 mm GRANITÉ



verre trempé sécurit 4 mm MONUMENTAL JAUNE

autres matériaux en **option** :
tôle aluminium thermolaquée pleine, autres verres trempés, ...

Laura 1300

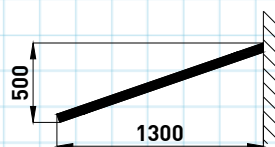
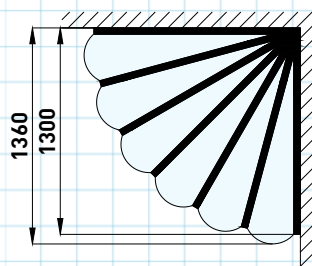

Laura 1800

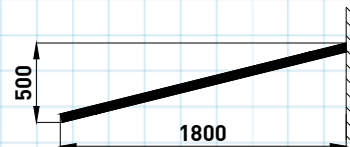
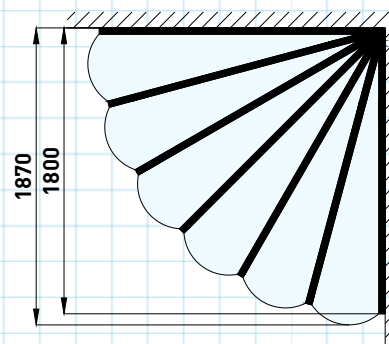

SIMULATEUR
des couleurs alu & de tous les remplissages

vision à **360°**



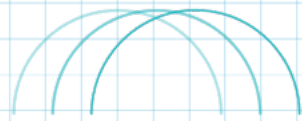

BVL SERRULAC

la technique a toujours raison dans le temps

MARGUERITE

© modèle déposé



*A la fois discrète et élégante,
elle possède le charme des anciennes
marquises en fer forgé.*



Les possibilités
de coloris
en **standard** :

RAL
9005
satiné

RAL
7016
satiné

RAL
9010
brillant

RAL
8019
satiné

en **option** :
- nuancier RAL
- d'autres finitions :
fine texture, sablée,
métallisée, ...

Les possibilités
de remplissages
en **standard** :



polycarbonate
plein 4 mm
INCOLORE

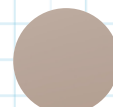

polycarbonate
plein 4 mm
BRONZE

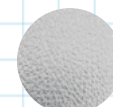

polycarbonate
plein 4 mm
GRANITÉ

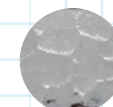

verre trempé
sécurité 4 mm
MONUMENTAL
INCOLORE



verre trempé
sécurité 4 mm
INCOLORE

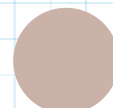

verre trempé
sécurité 4 mm
BRONZE

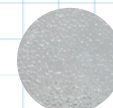

verre trempé
sécurité 4 mm
GRANITÉ

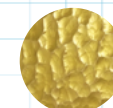

verre trempé
sécurité 4 mm
MONUMENTAL
JAUNE

autres matériaux en **option** :
tôle aluminium thermolaquée pleine, autres verres trempés, ...

SIMULATEUR
des couleurs alu
& de tous les
remplissages

vision à
360°



Marguerite 1600

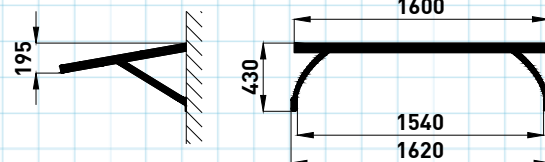
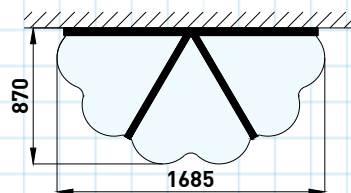

Marguerite 2000

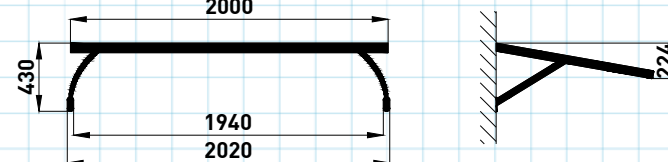
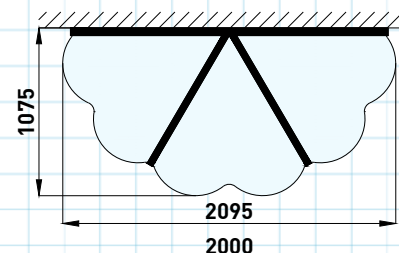

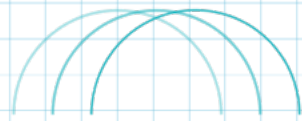

BVL SERRULAC

la technique a toujours raison dans le temps

PALACE

© modèle déposé



Entièrement composée de profilés en aluminium cintrés et soudés, équipée de plaques bombées, cette marquise est estampillée «grande classe» pour embellir les façades.



Les possibilités de coloris en **standard** :

RAL 9005 satiné

RAL 7016 satiné

RAL 9010 brillant

RAL 8019 satiné

en **option** :

- nuancier RAL
- d'autres finitions : fine texture, sablée, métallisée, ...

Les possibilités de remplissages en **standard** :



polycarbonate plein 4 mm INCOLORE



polycarbonate plein 4 mm BRONZE

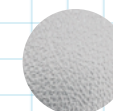

polycarbonate plein 4 mm GRANITÉ

SIMULATEUR
des couleurs alu & de tous les remplissages
vision à 360°



Palace 1600

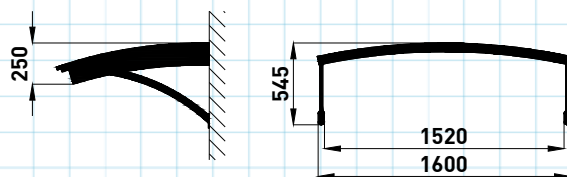
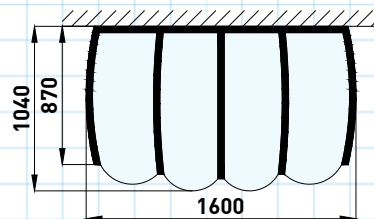

Palace 2000

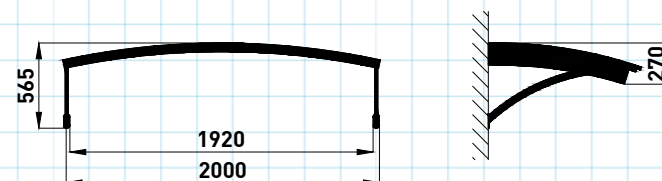
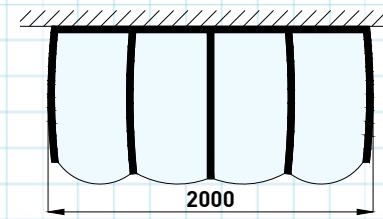

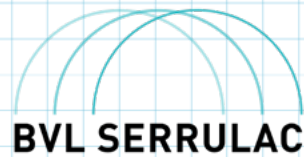

la technique a toujours raison dans le temps

ROMANE

© modèle déposé



Par sa forme en trapèze, elle apporte une protection couverte plus importante.



Les possibilités de coloris en **standard** :

RAL 9005 satiné

RAL 7016 satiné

RAL 9010 brillant

RAL 8019 satiné

en **option** :
- nuancier RAL
- d'autres finitions : fine texture, sablée, métallisée, ...

Les possibilités de remplissages en **standard** :



polycarbonate plein 4 mm INCOLORE



polycarbonate plein 4 mm BRONZE

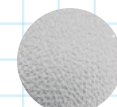

polycarbonate plein 4 mm GRANITÉ

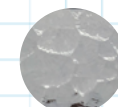

verre trempé sécurit 4 mm MONUMENTAL INCOLORE



verre trempé sécurit 4 mm INCOLORE

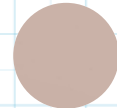

verre trempé sécurit 4 mm BRONZE

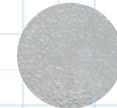

verre trempé sécurit 4 mm GRANITÉ

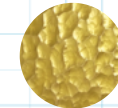

verre trempé sécurit 4 mm MONUMENTAL JAUNE

autres matériaux en **option** :
tôle aluminium thermolaquée pleine, autres verres trempés, ...

Les possibilités d'adaptation en **option** :



SIMULATEUR
des couleurs alu & de tous les remplissages
vision à 360°



Romane 1600

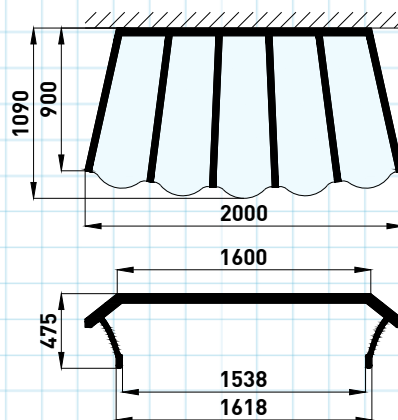

Romane 2000

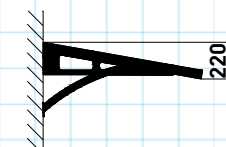
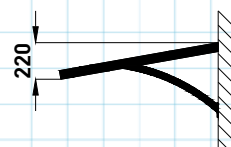
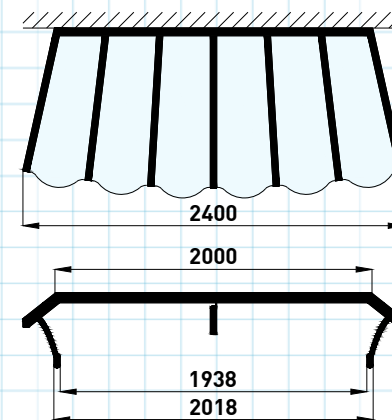

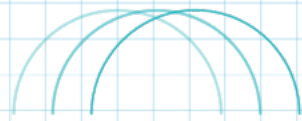

BVL SERRULAC

la technique a toujours raison dans le temps

TRIANON

© modèle déposé



*Traditionnelle par sa forme,
accueillante et lumineuse,
elle s'adapte à tous les types
de façade.*

Les possibilités
de coloris
en **standard** :

RAL
9005
satiné

RAL
7016
satiné

RAL
9010
brillant

RAL
8019
satiné

en **option** :

- nuancier RAL
- d'autres finitions :
fine texture, sablée,
métallisée, ...



Les possibilités
d'adaptation
en **option** :

Les possibilités
de remplissages
en **standard** :



polycarbonate
plein 4 mm
INCOLORE



polycarbonate
plein 4 mm
BRONZE

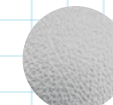

polycarbonate
plein 4 mm
GRANITÉ

autres matériaux en **option** :

tôle aluminium thermolaquée pleine, ...



SIMULATEUR

des couleurs alu
& de tous les
remplissages

vision à
360°



Trianon 1600

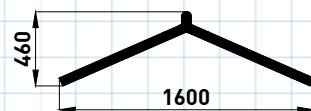
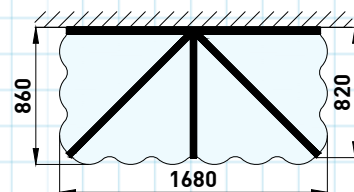

Trianon 2000

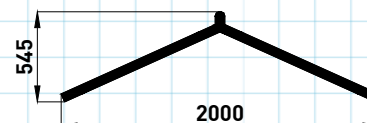
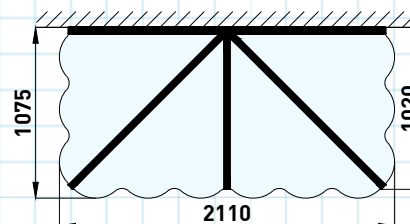

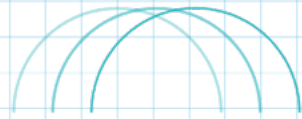

BVL SERRULAC

la technique a toujours raison dans le temps

TRIANON RÉTRO

© modèle déposé



De conception traditionnelle, elle possède le cachet des marquises d'autrefois.



Les possibilités de coloris en **standard** :

- RAL 9005 satiné
- RAL 7016 satiné
- RAL 9010 brillant
- RAL 8019 satiné

en **option** :
- nuancier RAL
- d'autres finitions : fine texture, sablée, métallisée, ...

Les possibilités de remplissages en **standard** :

polycarbonate plein 4 mm INCOLORE	polycarbonate plein 4 mm BRONZE	polycarbonate plein 4 mm GRANITÉ	verre trempé sécurit 4 mm MONUMENTAL INCOLORE
verre trempé sécurit 4 mm INCOLORE	verre trempé sécurit 4 mm BRONZE	verre trempé sécurit 4 mm GRANITÉ	verre trempé sécurit 4 mm MONUMENTAL JAUNE

autres matériaux en **option** :
tôle aluminium thermolaquée pleine, autres verres trempés, ...

Les possibilités d'adaptation en **option** :



Trianon rétro 1600

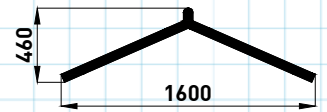
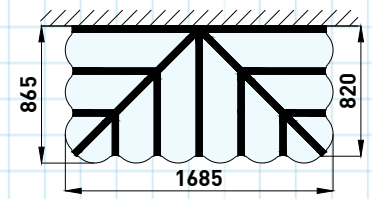

Trianon rétro 2000

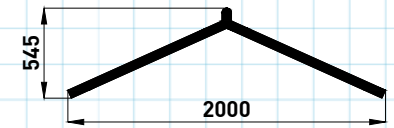
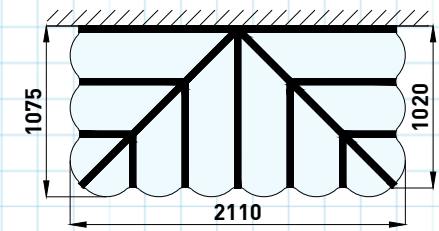

Trianon rétro HORS STANDARD

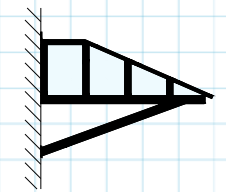
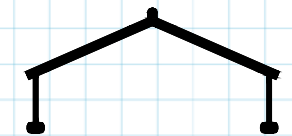
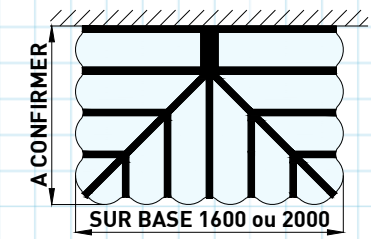

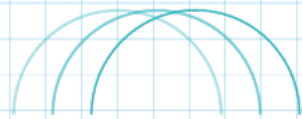

BVL SERRULAC

la technique a toujours raison dans le temps

VICTORIA

© modèle déposé



Déclinée en trois dimensions, elle s'intègre très facilement par sa forme simple à de nombreux types de constructions anciennes, ou modernes.

Les possibilités de coloris en **standard** :

RAL 9005 satiné

RAL 7016 satiné

RAL 9010 brillant

RAL 8019 satiné

en **option** :

- nuancier RAL
- d'autres finitions : fine texture, sablée, métallisée, ...



Les possibilités de remplissages en **standard** :



polycarbonate plein 4 mm INCOLORE



polycarbonate plein 4 mm BRONZE

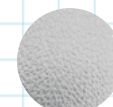

polycarbonate plein 4 mm GRANITÉ

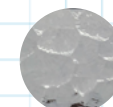

verre trempé sécurit 4 mm MONUMENTAL INCOLORE



verre trempé sécurit 4 mm INCOLORE

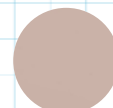

verre trempé sécurit 4 mm BRONZE

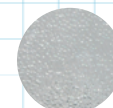

verre trempé sécurit 4 mm GRANITÉ

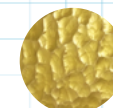

verre trempé sécurit 4 mm MONUMENTAL JAUNE

autres matériaux en **option** :

tôle aluminium thermolaquée pleine, autres verres trempés, ...

Les possibilités d'adaptation en **option** :



Victoria 1400

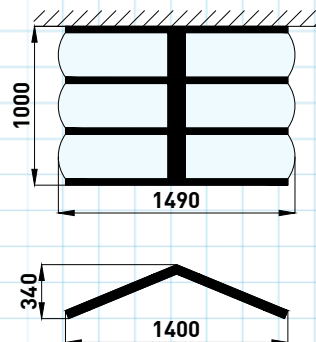

Victoria 1800

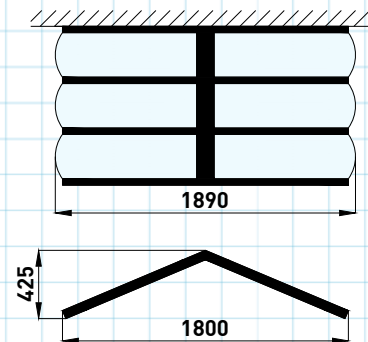

Victoria 2200

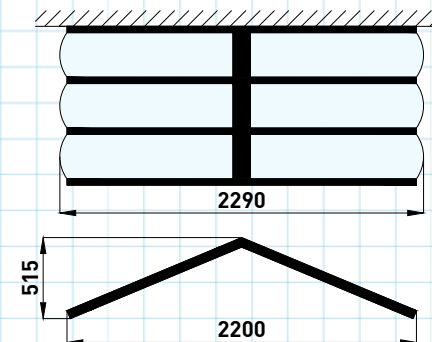

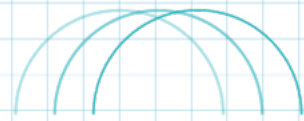

BVL SERRULAC

la technique a toujours raison dans le temps

VICTORIA BANDEAU

© modèle déposé



Cette version confère à votre entrée à la fois une touche rétro charmante, ainsi qu'une protection renforcée.

Les possibilités de coloris en **standard** :

RAL 9005 satiné

RAL 7016 satiné

RAL 9010 brillant

RAL 8019 satiné

en **option** :
- nuancier RAL
- d'autres finitions : fine texture, sablée, métallisée, ...



Les possibilités de remplissages en **standard** :



polycarbonate plein 4 mm INCOLORE



polycarbonate plein 4 mm BRONZE

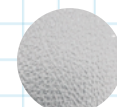

polycarbonate plein 4 mm GRANITÉ

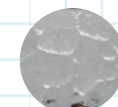

verre trempé sécurit 4 mm MONUMENTAL INCOLORE



verre trempé sécurit 4 mm INCOLORE

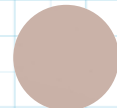

verre trempé sécurit 4 mm BRONZE

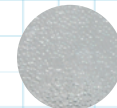

verre trempé sécurit 4 mm GRANITÉ

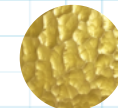

verre trempé sécurit 4 mm MONUMENTAL JAUNE

autres matériaux en **option** :
tôle aluminium thermolaquée pleine, autres verres trempés, ...

Les possibilités d'adaptation en **option** :



Victoria bandeau 1400

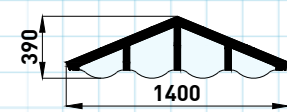
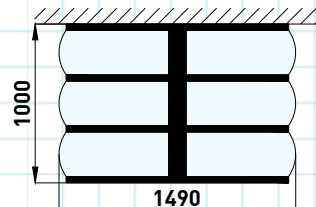

Victoria bandeau 1800

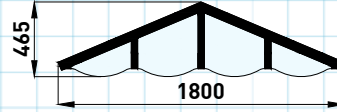
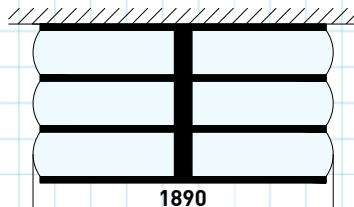

Victoria bandeau 2200

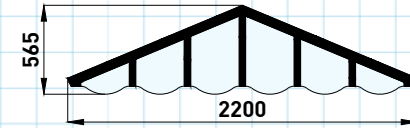
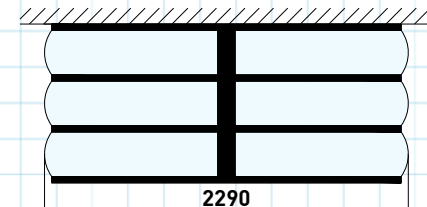

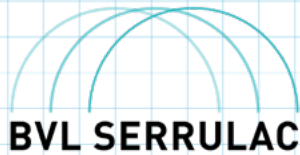

la technique a toujours raison dans le temps

STELLA

© modèle déposé

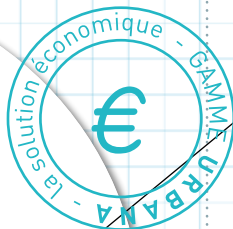

*Simple, fonctionnelle et économique,
Stella habille avec élégance
les petites entrées.*



Les possibilités
de coloris
en **standard** :

RAL
9005
satiné

RAL
7016
satiné

RAL
9010
brillant

RAL
8019
satiné

en **option** :

- nuancier RAL
- d'autres finitions :
fine texture, sablée,
métallisée, ...

Les possibilités
de remplissages
en **standard** :



polycarbonate
plein 3 mm
INCOLORE

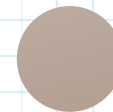

polycarbonate
plein 3 mm
BRONZE

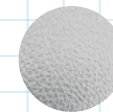

polycarbonate
plein 3 mm
GRANITÉ

autres matériaux en **option** :

tôle aluminium thermolaquée pleine, ...

SIMULATEUR
des couleurs alu
& de tous les
remplissages

vision à
360°



Stella 1400

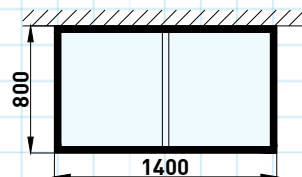

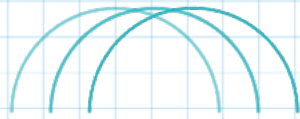

BVL SERRULAC

la technique a toujours raison dans le temps

VILA

© modèle déposé



*Son design simple et pur en fait
une marquise idéale pour
toutes les portes.*



Les possibilités
de coloris
en **standard** :

RAL
9005
satiné

RAL
7016
satiné

RAL
9010
brillant

RAL
8019
satiné

en **option** :
- nuancier RAL
- d'autres finitions :
fine texture, sablée,
métallisée, ...

Les possibilités
de remplissages
en **standard** :



polycarbonate
plein 4 mm
INCOLORE



polycarbonate
plein 4 mm
BRONZE

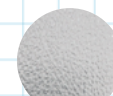

polycarbonate
plein 4 mm
GRANITÉ

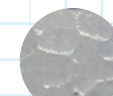

verre trempé
sécurit 4 mm
MONUMENTAL
INCOLORE



verre trempé
sécurit 4 mm
INCOLORE



verre trempé
sécurit 4 mm
BRONZE

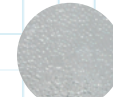

verre trempé
sécurit 4 mm
GRANITÉ

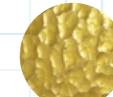

verre trempé
sécurit 4 mm
MONUMENTAL
JAUNE

autres matériaux en **option** :
tôle aluminium thermolaquée pleine, autres verres trempés, ...

Les possibilités
d'adaptation
en **option** :



SIMULATEUR

des couleurs alu
& de tous les
remplissages

vision à
360°



Vila 1400

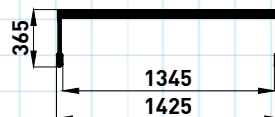
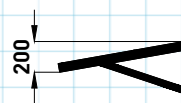
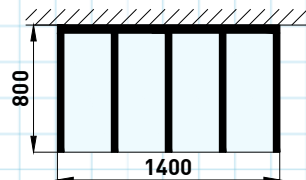

ROBUSTESSE, SANS AUCUN ENTRETIEN !

ÉPAISSEUR & SOUDURE

Les profils en aluminium utilisés sont d'une part,

+ épais que ceux de nos confrères,

et d'autre part, assemblés par **soudage (structure garantie 10 ans)**,

puis thermolaqués.

Résistance du thermolaquage
(procédé par poudrage) labellisé



en option : qualité marine labellisé



**LE MEILLEUR INSTALLATEUR
DE NOS PRODUITS,
TOUT PRÈS DE CHEZ VOUS :**